

NOTES:

1. MATERIAL: STAINLESS STEEL
2. MOUNT MATERIAL: BLACK ANODIZED ALUMINUM
3. RoHS: COMPLIANT

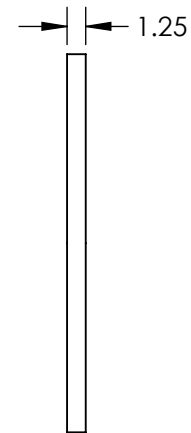
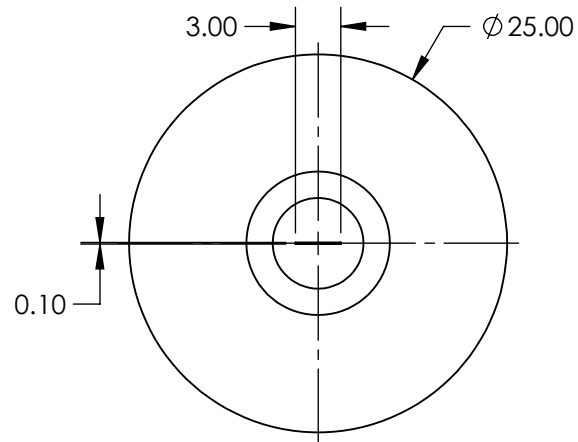
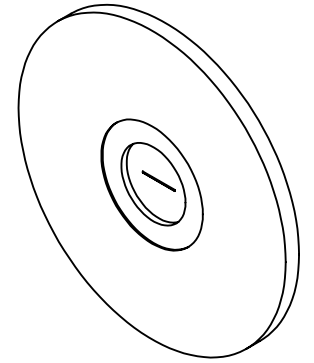

SPECIFICATIONS SUBJECT TO CHANGE WITHOUT NOTICE
DIMENSIONS ARE FOR REFERENCE ONLY

**FOR INFORMATION ONLY:
DO NOT MANUFACTURE
PARTS TO THIS DRAWING**

EO® Edmund Optics®

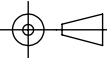
THIRD ANGLE PROJECTION 		TITLE	100µm x 3mm, MOUNTED, PRECISION AIR SLIT	
ALL DIMS IN	mm	DWG NO	58544	SHEET 1 OF 1