

NOTES:

1. SUBSTRATE:
ZERODUR
2. S2 TO BE PARALLEL TO S1 TO WITHIN <30 ARCSEC
3. COATING (APPLY ACROSS COATING APERTURE)
S1: PROTECTED GOLD
R(AVG) > 96% FROM 700-2000nm @ 0° AOI
R(AVG) > 96% FROM 2000-10000nm @ 0° AOI
S2: NONE

4. FINE GROUND SURFACE

5. CLEAR APERTURE AND COATING APERTURE ARE CENTERED ON SURFACE
6. SURFACE QUALITY SPECIFICATIONS APPLY ACROSS CLEAR APERTURE

7. ARROW ON EDGE POINTS TOWARDS 1/10TH WAVE SURFACE S1

8. ROHS: COMPLIANT

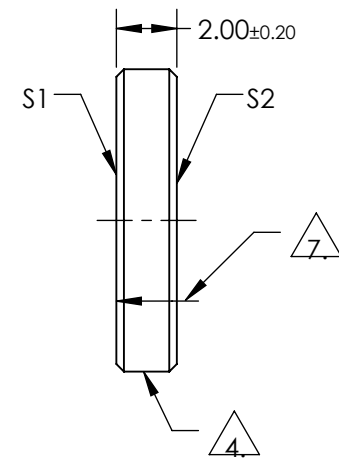
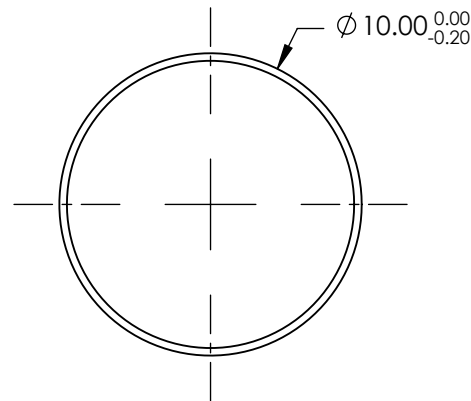

**FOR INFORMATION ONLY:
DO NOT MANUFACTURE
PARTS TO THIS DRAWING**

SPECIFICATIONS SUBJECT TO CHANGE WITHOUT NOTICE
DIMENSIONS ARE FOR REFERENCE ONLY

	S1	S2
SHAPE	PLANO	PLANO
SURFACE QUALITY	20-10	COMMERCIAL POLISH
SURFACE FLATNESS	0.10 WAVE	N/A
CLEAR APERTURE	Ø9.00	N/A
COATING APERTURE	Ø9.60	N/A
BEVEL	PROTECTIVE AS NEEDED	PROTECTIVE AS NEEDED

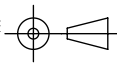
THIRD ANGLE PROJECTION 

ALL DIMS IN mm

 **Edmund Optics®**

TITLE: MIRROR 1/10 WV ZDUR GOLD 10 DIA

DWG NO: 39860

SHEET 1 OF 1