

**FOR INFORMATION ONLY:
DO NOT MANUFACTURE
PARTS TO THIS DRAWING**

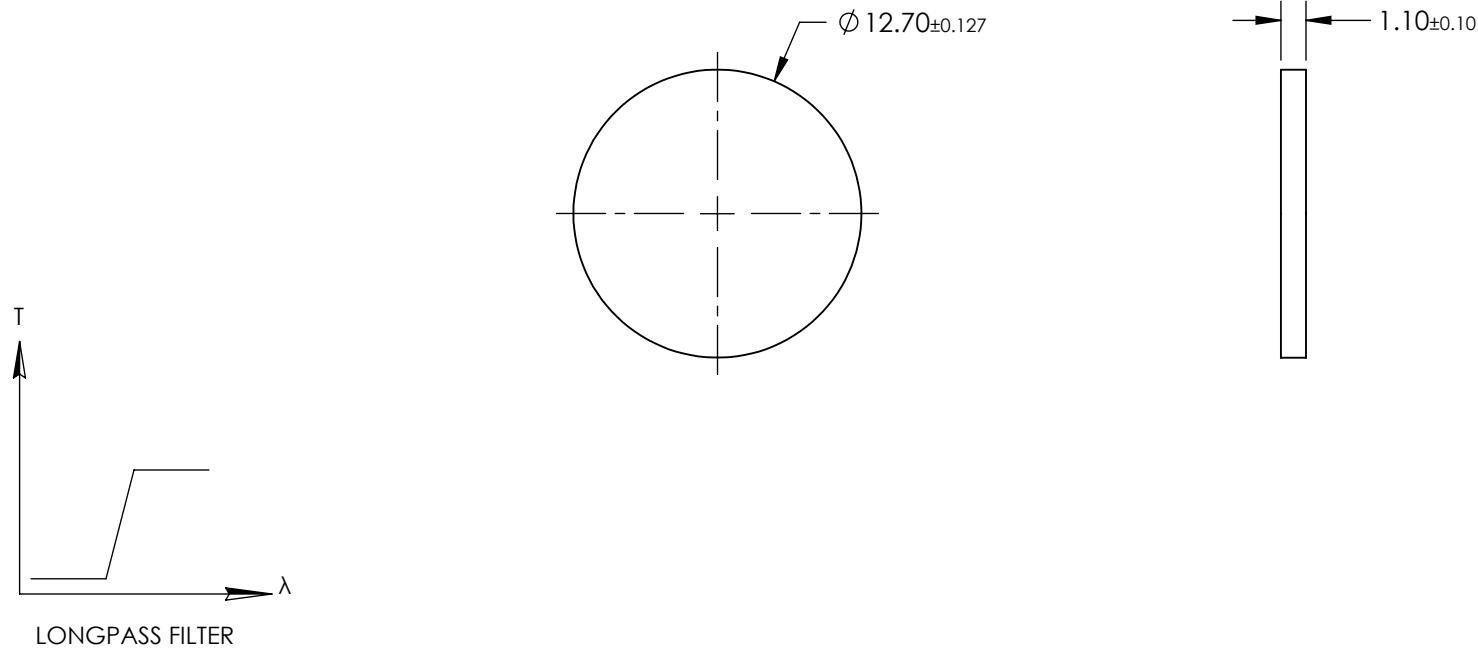

	VALUE
SHAPE	PLANO
CUT-ON WAVELENGTH (nm)	715±7
TRANSMISSION WAVELENGTH (nm)	735 - 2500
TRANSMISSION (%)	>90 (TYPICAL)
REJECTION WAVELENGTH (nm)	200 - 665
SURFACE QUALITY	80-50
CLEAR APERTURE (%)	90
DURABILITY, PHYSICAL	MIL-C-48497
DURABILITY, ENVIRONMENTAL	MIL-STD-810, METHOD 507.3, PRCEDURE III, MODIFIED TO 40 CYCLES
BEVEL MAX FACE	PROTECTIVE AS NEEDED

SPECIFICATIONS SUBJECT TO CHANGE WITHOUT NOTICE
DIMENSIONS ARE FOR REFERENCE ONLY

EO® **Edmund Optics**®

THIRD ANGLE PROJECTION	TITLE	715nm, 12.7mm DIA., COLORED GLASS REPLACEMENT LONGPASS FILTER	
ALL DIMS IN	mm	DWG NO	15450
			SHEET 1 OF 1