

NOTES:

1. LASER CLASS:
IIIb
2. BEAM DIAMETER(mm): 3.5 typical
BEAM DIVERGENCE: <5.0mrad
3. MODULATION FREQUENCY: 0 - 10kHz
4. OPERATING TEMPERATURE: -10 to 50 °C
OPERATING VOLTAGE: 5V
5. OUTPUT POWER: 1mW
6. WAVELENGTH RANGE: 980±5 nm

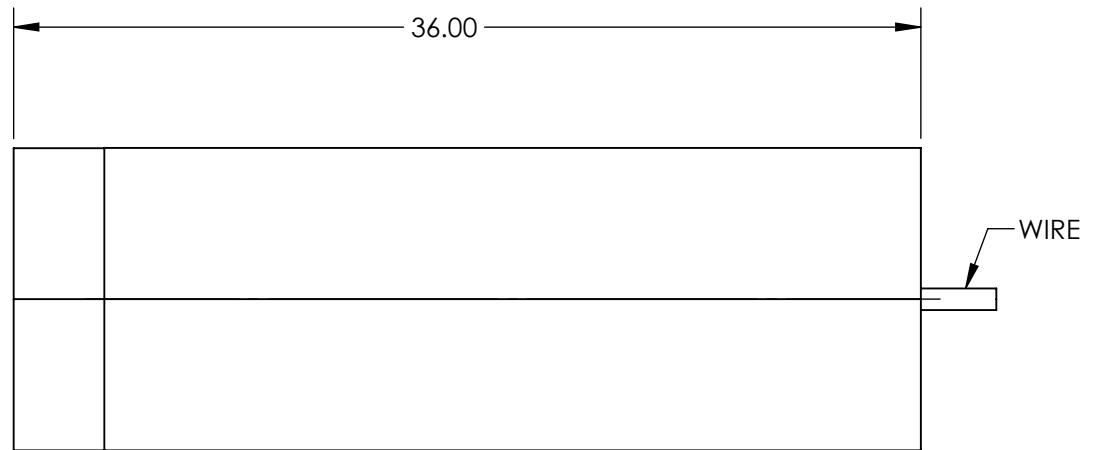
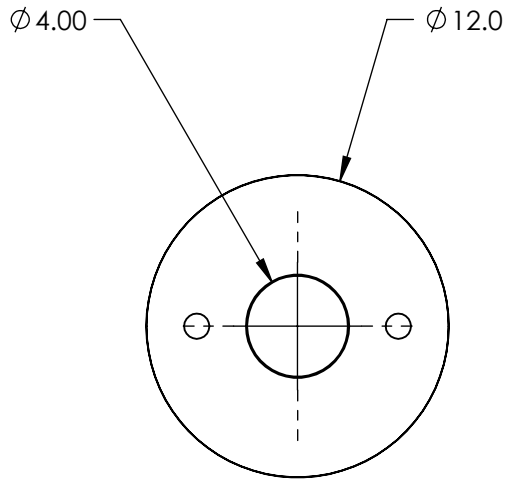
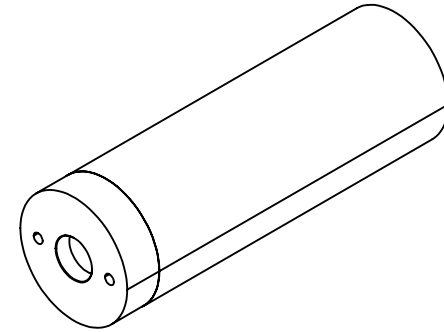

SPECIFICATIONS SUBJECT TO CHANGE WITHOUT NOTICE
DIMENSIONS ARE FOR REFERENCE ONLY

**FOR INFORMATION ONLY:
DO NOT MANUFACTURE
PARTS TO THIS DRAWING**

EO® Edmund Optics®

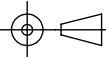
THIRD ANGLE PROJECTION 		TITLE	1mW, 980nm Alignment Laser Diode	
ALL DIMS IN	mm	DWG NO	19456	SHEET 1 OF 1