

# Infrared LED Lights Instruction Guide

Thank you for purchasing a CCS product. To ensure proper use of the product, please read this instruction guide before use and keep it for your future reference.

## 1 Introduction

This product is an LED light used for machine vision and industrial inspection. Do not use the product for other applications.



Infrared light emitting diodes are mounted onto this product. Even though the radiation is invisible, the LEDs emit IR radiation when the illumination is turned ON.

The peak wavelength of the product corresponds to IR-A range (780 to 1400 nm). IR radiation in the IR-A range may result in an adverse influence on human eyes. Do not expose human eyes to IR radiation.





## 2 Important Information for Equipment Safety - Read Before Use -











This product has been designed with full consideration of safety. However, incorrect usage of the product may result in fire, electric shock, or other serious damages. Please ensure to follow the conditions below.







**The following symbols are used in this instruction guide to indicate and classify the relative importance of warnings and cautions.**

|  |   |  |   |
|--|---|--|---|
|  <b>Warning</b> | Indicates that incorrect usage may result in serious injury or death. |  <b>Caution</b> | Indicates that incorrect usage may result in injury or property damage. |
|--|---|--|---|

**The following symbols in the instruction guide indicate and classify the precautions.**

|  |  |  |   |
|--|--|--|---|
|  <b>PROHIBITED</b><br> <b>DISASSEMBLY PROHIBITED</b><br> <b>DO NOT TOUCH WITH WET HANDS</b><br> <b>DO NOT SUBJECT TO MOISTURE</b> | These symbols indicate prohibited actions. |  <b>MANDATORY ACTIONS</b> | This symbol indicates required actions. |
|--|--|--|---|

|  <b>Warning</b>   |  |
|--|--|
| Do not disassemble or modify the product. Doing so may result in fire or electric shock.   |  <b>DISASSEMBLY PROHIBITED</b>      |
| Do not touch the product or cables with wet hands. Doing so may result in electric shock.  |  <b>DO NOT TOUCH WITH WET HANDS</b> |
| Make sure that the product is free of moisture or any liquid. Exposure to water may result in fire, electric shock.  |  <b>DO NOT SUBJECT TO MOISTURE</b>  |
| Turn off the Control Unit for the LED light when installing, unmounting or cleaning the product. Failure to do so may cause a pain in your eye, impaired eyesight or electric shock.   |  <b>MANDATORY ACTIONS</b>           |
| If abnormal condition occurs such as fuming, heat, smell, noise, or so on, stop using the product immediately, turn the power off, and unplug the power cord. A fire or electric shock may result if the product is kept used.                         |  <b>MANDATORY ACTIONS</b>           |
| Do not look at the radiating surface of the light directly while it is turned on. Also, do not turn it towards others. Doing so may cause a pain in the eye or impaired eyesight.  |  <b>MANDATORY ACTIONS</b>           |
| This product generates high temperatures. Do not touch the product while it is turned on or immediately after it is turned off, or burning may result. Provide cooling with a fan or other ventilation if the product is to be used in a closed space. |  <b>MANDATORY ACTIONS</b>           |
| Connect or disconnect the cable only after turning off the Control Unit for the LED light. Failure to do so may result in circuit damage, fire caused by a minute spark, or electric shock.  |  <b>MANDATORY ACTIONS</b>           |
| Make known to all personnel concerned the risk of ultraviolet radiation. Failure to do so may cause incorrect handling.  |  <b>MANDATORY ACTIONS</b>           |

|  <b>Caution</b>   |  |
|--|--|
| Do not use user-made cables. Doing so may cause product failure. Use the CCS extension cable if it is necessary to extend the distance between the light and the control unit.                     |  <b>PROHIBITED</b>        |
| Be careful of static electricity. Damage to the LED light may occur, if a person charged with static electricity touches it. Keep the product away from all items charged with static electricity. |  <b>PROHIBITED</b>        |
| Do not drop the product or subject it to impact. Doing so may cause the product to malfunction.  |  <b>PROHIBITED</b>        |
| Use a control unit that is suitable for the product ratings. Using an incorrect control unit can cause product failure.  |  <b>MANDATORY ACTIONS</b> |
| Use a standard Extension Cable that is manufactured by CCS. However, if the cable is too long, the light intensity will decrease due to voltage drop caused by the DC resistance of the cable.     |  <b>MANDATORY ACTIONS</b> |

**Do not use the product in the following situations.**

- Under conditions or in an environment not described in this Instruction Guide.
- In nuclear energy control systems, railroad systems, aviation systems, vehicles, combustion equipment, medical equipment, amusement machines, or safety equipment.
- In applications involving serious risk to life or property, particularly applications demanding a high level of safety.

**Please install the product to locations with following conditions. Incorrect installation location may cause product failure.**

- In a flat and stable location with minimal vibration.
- Well-ventilated places with minimal dust.
- Places that are not subject to sudden temperature changes.
- Places away from water faucets, boilers, humidifiers, air conditioners, heaters, or stoves.
- Places free from any water, oil, liquid, chemical, or steam.
- Places with sufficient airflow to cool the product.
- Places free from corrosive or combustible gas.

**Use the product under the following conditions.**

**Using the product under any other conditions may damage the product.**

- Operating temperature: 0 to 40°C, Humidity: 20 to 85%RH (with no condensation)
- Storage temperature: -20 to 60°C, Humidity: 20 to 85%RH (with no condensation)

If you are using a water-cooled LED light, see the specification sheet for details.

## 3 Product Information

### ● Tag

The following tag is attached to the cable on the LED Light. The color of the label indicates the luminescence color of the Light. The back of the tag there is a name label that gives the model number, power consumption, and serial number. Be sure to check the contents before using the product and handle the label with care.

#### Tag Example

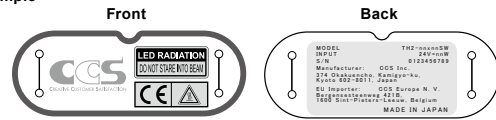

### ● Tag Position

The illustration shows the position of the tag on product. Contact CCS if there are any tags missing or damaged or if the contents are not legible.

#### Tag Position Example

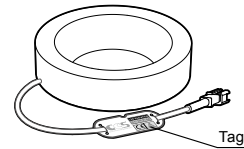

## 4 Wire Connection

**1 Make sure that the Control Unit for the LED Lights is turned off.**  
\*Read the Instruction Guide of the Control Unit for the LED Lights before use.

**2 Refer to the illustration below and connect the light cable to the Control Unit output connector.**

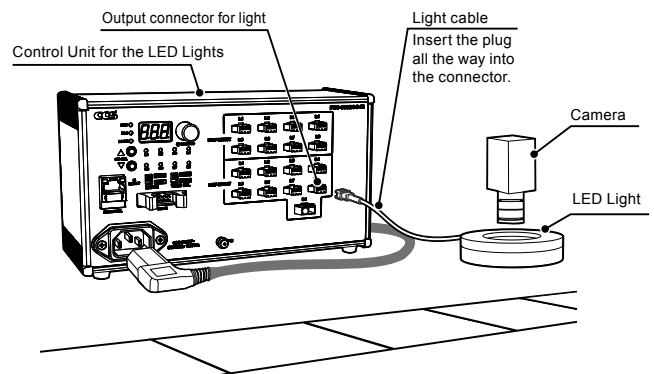

- Connection example -

**Caution** If the LED elements of the LED Light are exposed from the case, do not touch, stain, or damage them. Doing so may cause the LED Light to malfunction.

## 5 Operating Instructions

**Caution** Do not expose human eyes to IR radiation. Also, make known to all personnel concerned the risk of IR radiation.

- 1 Connect power cord to inlet and wall socket to turn on the Control Unit for the LED Lights.
- 2 Focus the imaging device, such as a camera, onto the inspection object.
- 3 Adjust light range, light angle, and radiant quantity to optimize images.

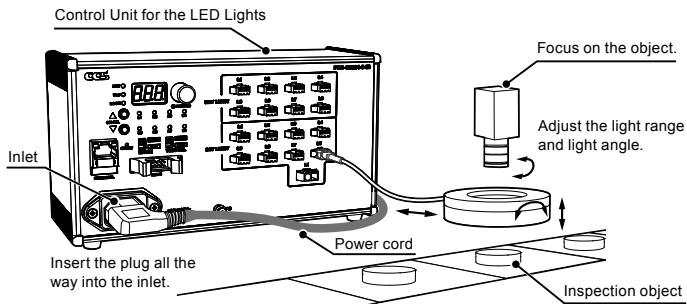

- Imaging example -

Use the Control Unit for the LED Lights to adjust the radiant quantity.

- Read the Instruction Guide of the Control Unit for the LED Lights before use.
- When you see the LEDs of the product, you may find some LEDs lit and others do not. This is because irradiation from the LEDs sometimes include visible light. The LED emits IR radiation even when it seems not to light, so that do not look at the radiating surface of the product directly by the naked eye. To check out the lighting failure of the LED, use a camera to do it by indirect means. You can also check it out through an LCD display of the general-purpose digital camera or mobile phone.

-5-

-7-

## 6 Control Units

When connecting a control unit to this product, use following CCS Control Units for the LED Lights.

Select a Control Unit to match the application and purpose. When making the selection, confirm that the total power consumption of the connected lights will be within the Control Unit output power specifications. In addition, independent control is enabled by selecting a Control Unit with the number of channels corresponding to the number of input connectors for the Lights that are used.

A compatible Control Unit is necessary to connect HLV-series Spot Lights.

Read the instruction guide of the Control Unit for the LED Lights before use.

### ● Digital Control Units (Pulse Duty Control)

The digital Control Unit is able to control radiant quantity with a PWM light control system. The setting can be made manually or controlled externally from a PLC or image processing device. The external power control of the LED Light requires a CCS External Control Cable.

### ● Analog Control Units (Constant Voltage Control)

The analog Control Unit providing stepless intensity control through variable voltage control. It is ideal for continuous use with cameras having a fast shutter speed.

### ● Overdrive Control Units

The Overdrive Control Unit enables LED Lights to be used with strobes. By overdriving\* the voltage, a current several times higher than normal current will flow. Therefore, it enables the Lights to emit few times brighter than using the ON/OFF control function.

Contact CCS for whether your LED light can be used with the Overdrive Control Unit.

\* Overdrive: A state in which voltage raises instantly in excess of the rated voltage.

Contact CCS for further inquiries on new products and other Control Unit information.

• Contents of this Instruction Guide may be changed without prior notice.  
• Illustrations used in this Instruction Guide may differ from actual products.  
• CCS maintains the copyright on this Instruction Guide. Unauthorized transfer or reproduction is strictly prohibited.

**CCS CCS Inc.**

<http://www.ccs-grp.com/>

Copyright© 2018 CCS Inc. All Rights Reserved.  
Descriptions in this instruction guide are based on information available as of October 2018. KZ00106-T002-006

-6-

-8-