



Single
Broadband
VIS-NIR LED

Flexible light



Suited for HSI
machine vision

Uniform
spectral emission

Adjustable
angle



HSI



IP5X

CE

RoHS

UK
CA



effiFLEX-HSI

Hyperspectral VIS-NIR LED bar light

COLLECT MORE DATA WITH HYPERSPECTRAL IMAGING

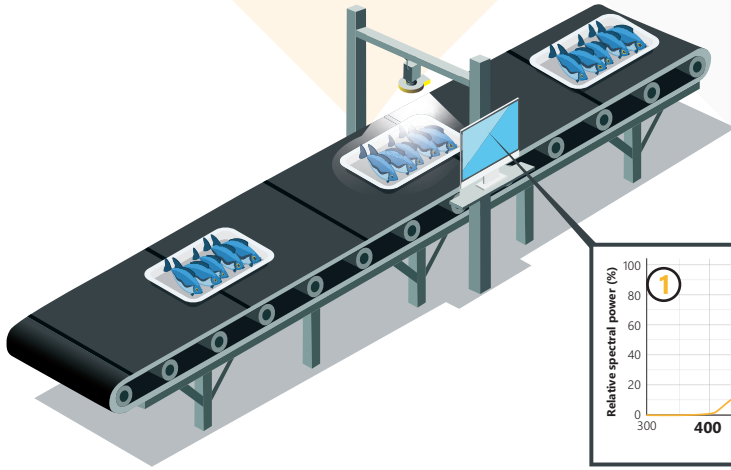

Hyperspectral imaging is an emerging technology in machine vision that integrates conventional imaging with spectroscopy. An enormous range of new applications for image processing in the visible-NIR region of the spectrum are now possible using this technique.

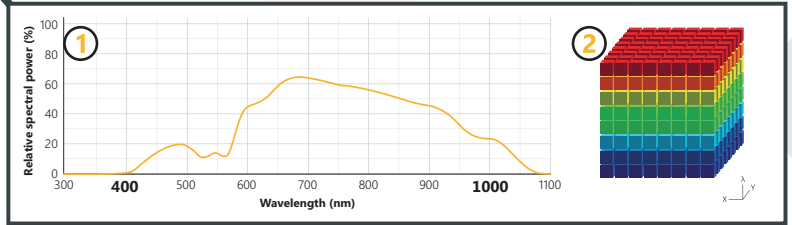

Here an example of an application using Efflux HSI lighting for optical control on fishes.

HSI lightings coupled with hyperspectral cameras allow to access both spectral and spatial information at the same time (2: hyperspectral data cube). In this case, spectral signature (1) can be access in a rapid and efficient way to ensure the good quality of products.

HYPERSPECTRAL ILLUMINATION FOR A WIDE VARIETY OF DOMAINS

Some examples

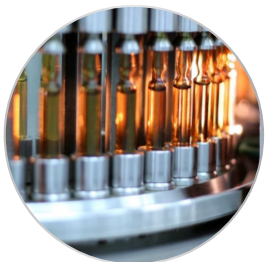

Medical and pharmaceutical analysis



Waste sorting and recycling



Hyperspectral microscopy



Food sorting and quality analysis



Defect inspections

SOLUTIONS FOR AREA SCAN AND LINE SCAN CAMERAS

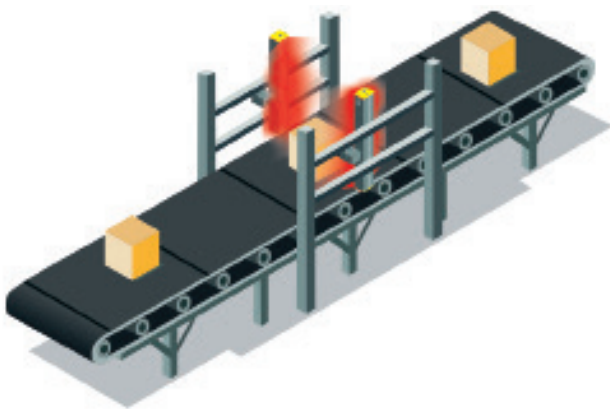

The EFFI-FLEX-HSI provides homogenous hyperspectral lighting, with various spot sizes for area scan camera applications.

The flexibility of the EFFI-FLEX-HSI makes it ideally suited for many fields of industrial applications (machine vision for quality control, pick and place, ...).

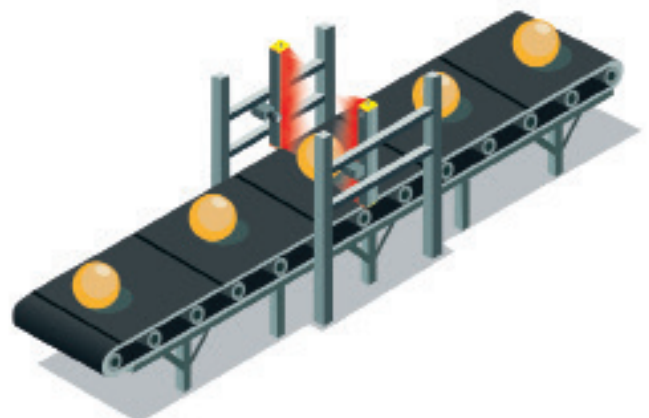

The EFFI-FLEX-HSI offers two solutions to obtain homogenous hyperspectral linear lighting. Those solutions have been design to perfectly fit line scan cameras needs in terms of illumination.

Equipped with the line scan options, the EFFI-FLEX-HSI delivers ideal lighting to obtain high-resolution images of moving materials.

TECHNICAL SPECIFICATIONS

Illumination Mode	Strobe or Continuous
Spectrum	400-900nm (standard version) / 400-1000 nm (extended spectrum version) <i>Custom spectrum available upon request. Please contact Efflux.</i>
Power Supply	24V DC +/- 10%
Power Consumption	Depends on the size (Cf. page 6)
Connector	M12 - 5pins or M12 Power (T-Coded) - 4pins (depending on the power consumption)
Driver version	AutoStrobe (Analog Intensity Control (AIC) available in option)
Response Time	Rising: 15µs / Falling: 10µs
Max duty cycle	30 % in AutoStrobe mode
Input signal	PNP trigger input: Light ON: from 5V to 24V / Max. signal consumption: 1mA
Weight	weight (in kg) = 0,1 + 0,3 x Optical length (in mm)
Dimensions	51mm x 49mm x (Length = Optical length + 35mm) (Cf. page xx)
Material	Device body: Aluminium wallow / Window: PMMA
Fastener	One T-slot on the back for 8mm T-nut (M6 recommended), and one slot on the side for M6 hex nut
IP rating	IP5X (IP67 and IP69K versions available)
Working temperature	0°C to 50°C
Heating time	Spectral stability is reached after an hour of operation at ambient temperature (25°C)
Regulations	CE - RoHS - REACH - WEEE - IEC 62471 - China RoHS
Country of Origin	France

PART NUMBER KEY

STANDARD VERSION

EFFI-FLEX-HSI	- XXXX	- WW	- PP
	Optical Length (mm)	Window	Lens position
	100	TR (Transparent)	P0 (90°)
	200	SD (Semi-diffuse)	P1 (45°)
	300	OP (Opaline)	P2 (25°)
	... All 100mm		P3 (10°)
	2900		

AVAILABLE OPTIONS: REFERENCES

OPTIC	
Polarizer accessory	EFFI-FLEX-HSI-XXXX-TR-PP-POL-NIR-90° (Cf. page 5)
Linescan accessory	EFFI-FLEX-HSI-XXXX-TR-P3-LS (Cf. annexe line scan solutions page 14)
Cylindrical lens Version	EFFI-FLEX-HSI-XXXX-TR-P1-LS-CYL (Cf. annexe line scan solutions page 14)
Extended spectrum version (400-1000nm)	EFFI-FLEX-HSI-X2-XXXX-910-970-WW-PP-ELS-UUU (Cf. annexe page 12) X2: twice more LEDs. / ELS: AIC version only / UUU: adjustment range of the AIC (24V, 10V or 5V)
ELECTRONIC	
AIC Version (Analog Intensity Control)	EFFI-FLEX-HSI-XXXX-WW-PP-ELS-VVV-UUU VVV: Max LED current, standard at 350mA / UUU: adjustment range of the AIC (24V, 10V or 5V) ELS-IN Version: Inverse version (Intensity max @0V instead of 24V)
NPN trigger Version	EFFI-FLEX-HSI-XXXX-WW-PP-NPN
Kit with diffusers	EFFI-FLEX-HSI-XXXX-KIT
MECHANIC	
IP67 Version	Please refer to the EFFI-Flex-CPT documentation.
IP69K Version	Please refer to the EFFI-Flex-IP69K documentation.
Longer length	Up to 6 meters. Please contact Efflux.

OPTICAL SPECIFICATONS - STANDARD VERSION

MANY POSSIBLE CONFIGURATIONS IN JUST ONE LIGHT

Diffusers

Depending on the uniformity needed for the application, the user can easily change the diffuser to one that fulfills the application requirements.

TR : Transparent



SD : Semi-diffuse



OP : Opaline



Change your configuration by hand.

Lens position

The EFFI-Flex-HSI offers flexible lens positioning to control the beam angle. The user can adjust it by himself: the angle can be widened by moving the lens closer to the LEDs or narrowed by moving the lens further away from the LEDs.

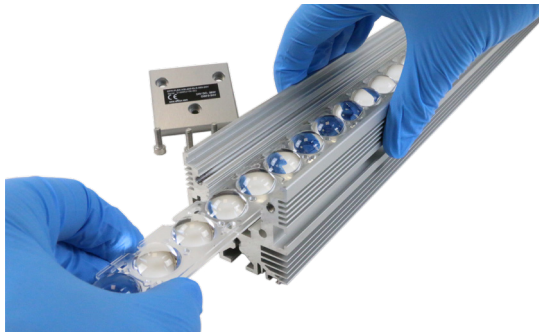

Change your configuration by hand.

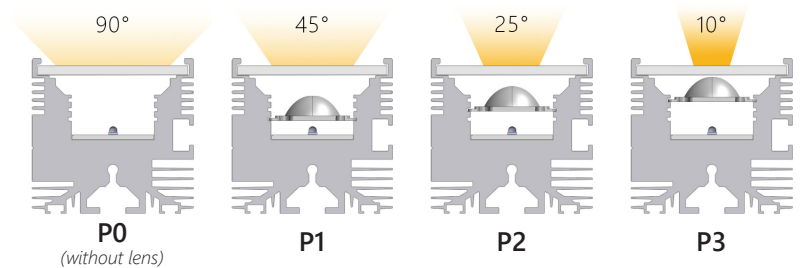

Optical impact

Data for the EFFI-Flex-HSI with transparent window and different lens positions P0, P1, P2, P3.

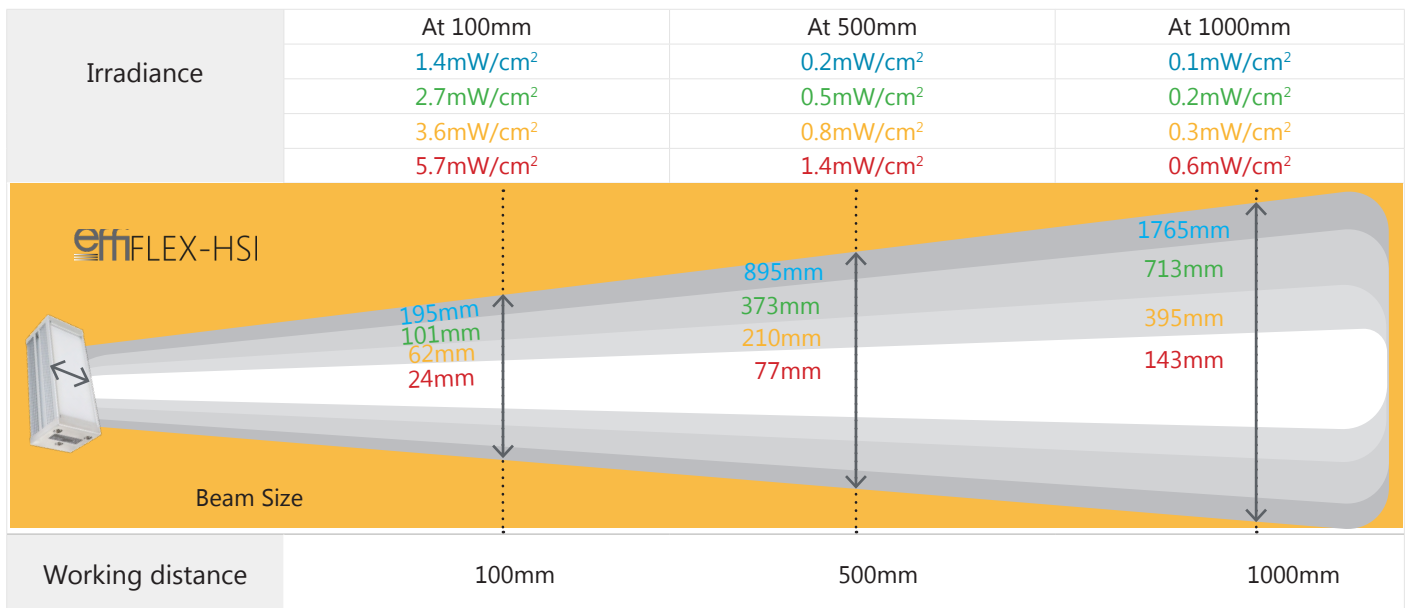

Optical power ratio for the different windows
(In lens position P2 and at working = distance 400mm)

Transparent window	Semi-diffuse window	Opaline window
100%	85%	15%

SPECTRUM

EFFI-Flex-HSI standard spectrum

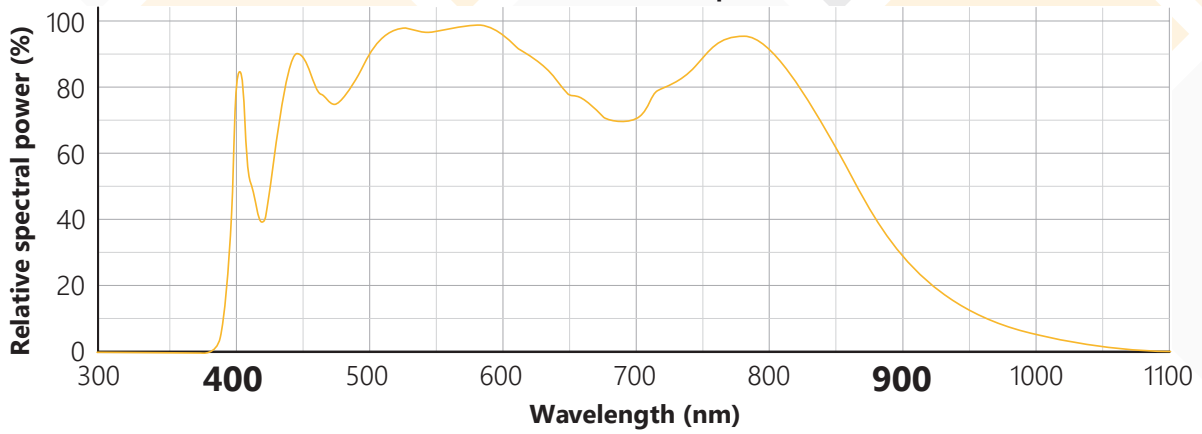

The EFFI-Flex-HSI requires time to stabilize his spectral emission. Please note that during this stabilization, the spectral power may decrease by maximum 15%.

At ambient temperature 25°C, in continuous mode this stability is reached an hour after switching on the product.

Evolution of the broadband spectrum during stabilisation time effiFLEX-HSI

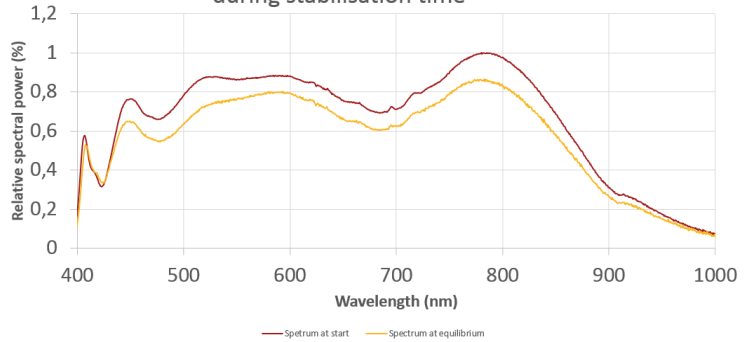

OPTION: POLARIZER ACCESSORY

Using polarizers, on the Effilux light and on the camera, it is possible to eliminate glare from your workpiece making it easier to acquire a suitable image for the application.

The user can insert directly the polarizer inside the EFFI-Flex-HSI, under the window.



Without polarizer

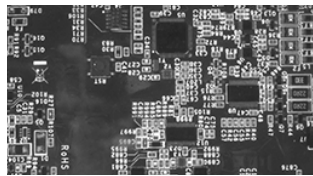

With polarizer



Important notes:

- With the EFFI-Flex-HSI, it is necessary to use a VIS-NIR polarizer (Ref : EFO-FLEX-POL-XXX-NIR-90°).
- The polarization is optimal with a transparent window, the use of diffuser can depolarize the light.

ELECTRONICAL SPECIFICATIONS - STANDARD VERSION

WIRING LAYOUT - STANDARD VERSION

The EFFI-Flex-HSI requires 24V DC input power. Note the trigger pin needs to be connected either to the 24V DC signal for Continuous mode or to a PNP Trigger signal for AutoStrobe mode.

M12 - 5 pins

male connector

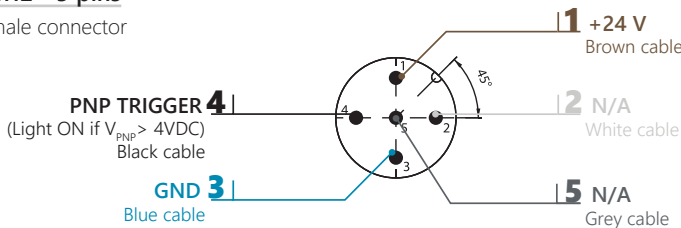

M12 Power (T-coded) - 4 pins

male connector

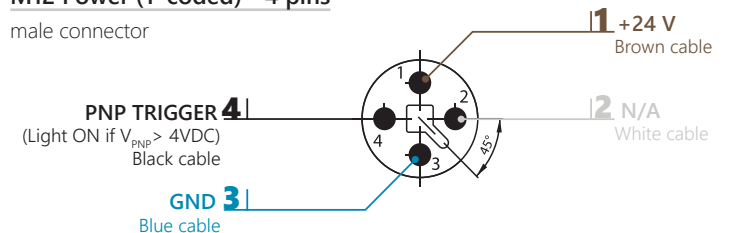

AUTOSTROBE FEATURE

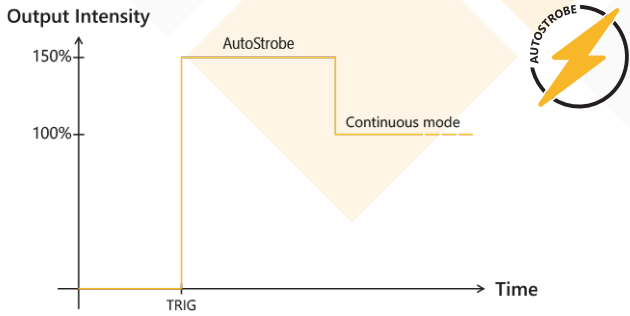

The integrated driver with AutoStrobe feature allows for 150% increased intensity while being strobed when compared to continuous mode. Strobing time lasts for 2 seconds.

Respect a duty cycle of 30% in strobe mode.

Response time	
Rising time	15µs
Falling time	10µs

OPTION DRIVER ELS: AIC VERSION

The standard product (AutoStrobe) is not dimmable, EFFILUX offers an alternative electronic configuration suitable for continuous use and linear applications. This ELS driver version allows you to adjust the light intensity of the product according to the input signal: AIC Version (Analog Intensity Control).

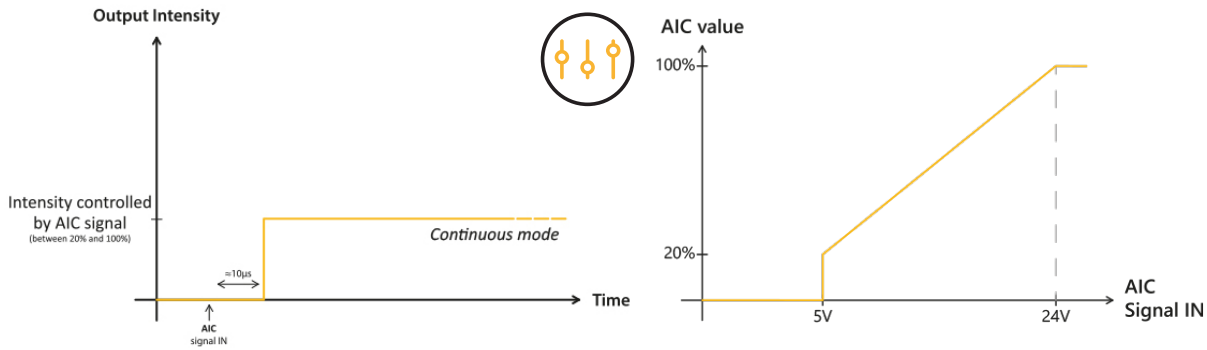

The wiring layout of the AIC version is similar to the standard wiring layout. The signal input (PNP trigger in the standard version) has to be replaced by the Analog Intensity Control signal in order to adjust the light intensity.

POWER CONSUMPTION AND CONNECTOR TYPE

Depending on power consumption, the EFFI-Flex-HSI has a standard M12 connector or an M12 Power connector. The exact power consumption of the product is always indicated on the product's stickers.

MAX POWER CONSUMPTION (STANDARD VERSION)																		
Optical length (mm)		20	60	100	200	300	400	500	600	700	800	900	1000	1100	1200	1300	1400	...
Standard AutoStrobe	P _{peak}	5W	5W	15W	20W	25W	35W	45W	55W	65W	70W	80W	90W	100W	105W	115W	125W	...
	P _{cw}	2W	5W	8W	15W	20W	30W	35W	45W	50W	55W	60W	65W	70W	75W	85W	90W	...
ELS350 Version		5W	5W	10W	15W	20W	30W	35W	40W	50W	55W	60W	70W	75W	80W	90W	95W	...

M12	M12 Power
5 pins	4 pins

MAX POWER CONSUMPTION (STANDARD VERSION)																
Optical length (mm)		1500	1600	1700	1800	1900	2000	2100	2200	2300	2400	2500	2600	2700	2800	2900
Standard AutoStrobe	P _{peak}	135W	140W	150W	160W	170W	175W	185W	195W	205W	210W	220W	230W	240W	245W	255W
	P _{cw}	95W	105W	110W	115W	120W	125W	135W	140W	145W	150W	160W	165W	170W	175W	180W
ELS350 Version		95W	105W	110W	115W	120W	125W	135W	140W	145W	150W	160W	165W	170W	175W	180W

P_{peak} is corresponding to the peak consumption during the autostrobe and P_{cw} is corresponding to the power consumption during the continuous mode, after the AutoStrobe.

M12	M12 Power
5 pins	4 pins

MECHANICAL SPECIFICATIONS

GENERAL DIMENSIONS

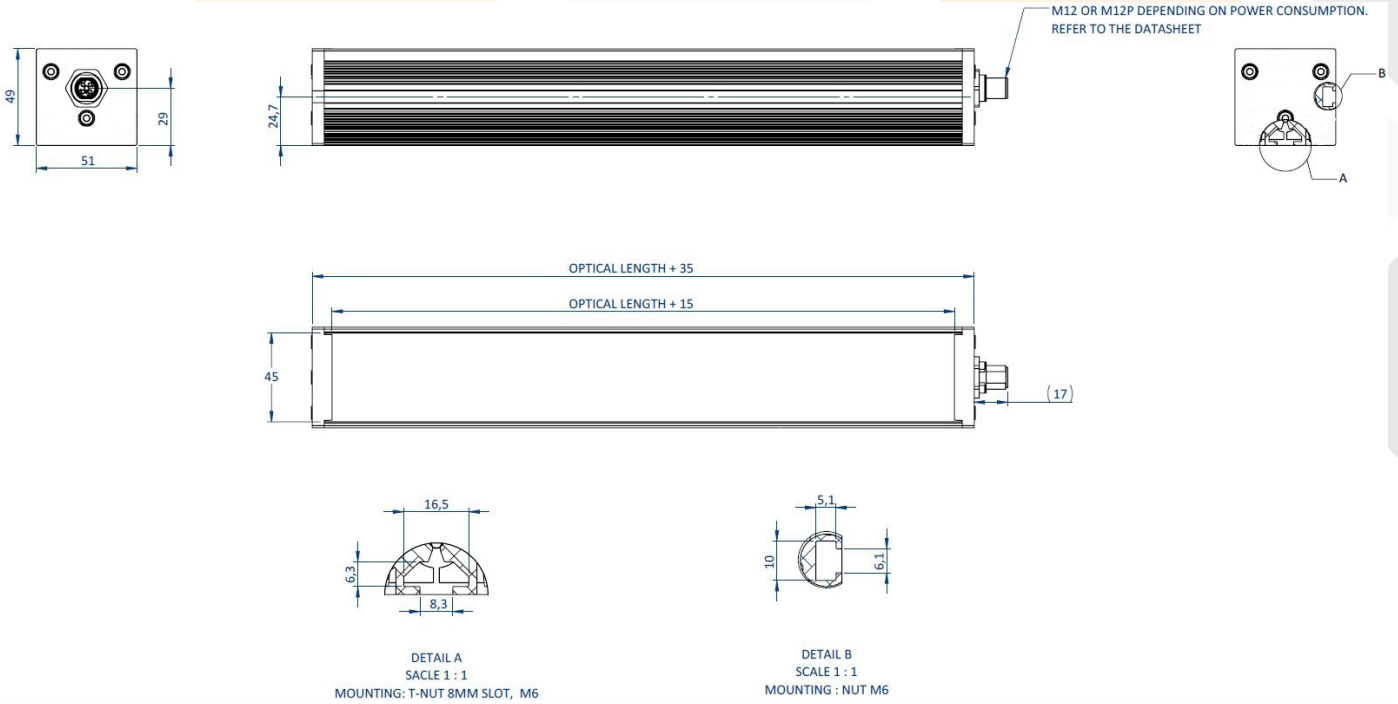

MECHANICAL VERSIONS OF THE EFFI-Flex-HSI

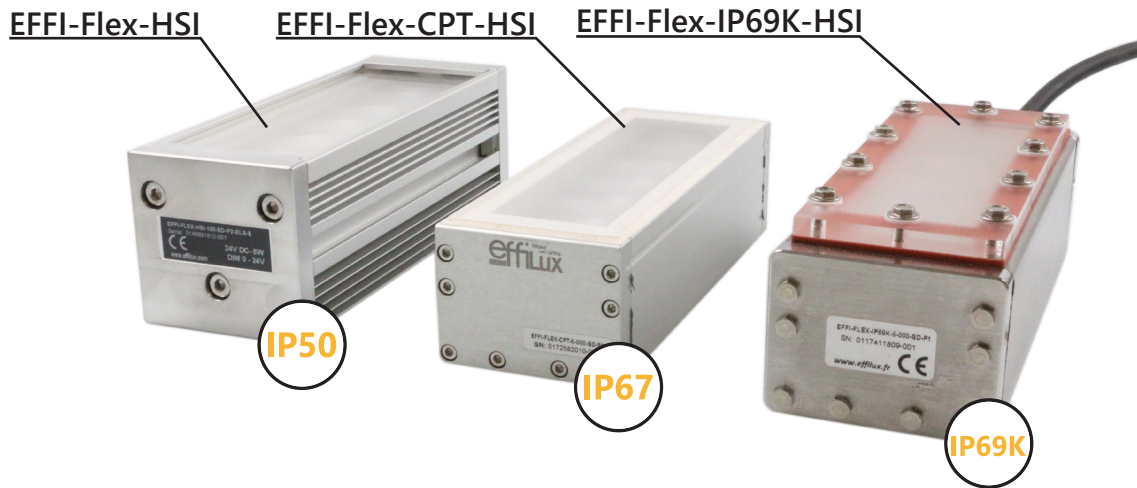

	IP rating	"Openable" product	Water cooling available	Anti-dust conception	Food version
EFFI-Flex-HSI	IP50	✓	✗	✗	✗
EFFI-Flex-CPT-HSI	IP67	✗	✓	✓	✗
EFFI-Flex-IP69K-HSI	IP69K	✗	✗	✓	✓

Please, refer to the dedicated documentation of the EFFI-Flex-CPT and the EFFI-Flex-IP69K.

ACCESSORIES

Please refer to the specific documentation for additional information on the accessories of the EFFI-Flex-HSI.

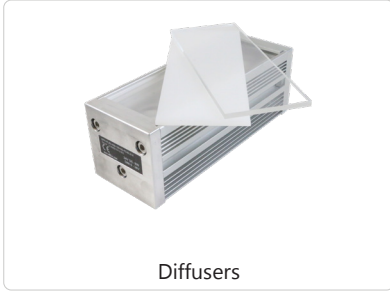

Diffusers

Transparent: EFFO-FLEX-TR-XXX*
Semi-diffuse: EFFO-FLEX-SD-XXX*
Opaline: EFFO-FLEX-OP-XXX*



Polarizer / Linescan

Polarizer: EFFO-FLEX-POL-XXX*-NIR-90°
Linescan: EFFO-FLEX-LS-XXX*



Extension Cables

M12 Female to Flying leads:
EFFC-CAB-M12-F-5-D-LZ*
M12 Female to M12 Male:
EFFC-CAB-M12-FM-5-DD-LZ*



Fasteners

T-Nut Kit: EFFV-BOLT-0011
Pivot joint Kit: EFFM-1-002



Power supplies

Power supply: EFFI-PWR- ...
Compact power supply:
EFFI-SPWR-090W-24V-102-YY*

*XXX = number of LEDs (Optical length (mm) / 20)
YY = type of outlet: UK, CH, EU, US
Z = cable length in meter: 2 / 5 / 10

CUSTOMIZATIONS



REGULATIONS

In accordance with machinery directive, the CE and UKCA marks indicate that the product complies with the relevant EU and UK legislation. Please refer to the "General warnings & precautions for use" for detailed informations regarding standards and regulations.



CONTACT INFORMATION

Please refer to the specific documentation (datasheet, user manual, drawing and general warnings & precautions for use) for complementary information.

Contents of this document are based on information available as of June-2021 and may be changed without prior notice.



EFFILUX
1, Rue de Terre Neuve
Mini Parc du Verger - Bâtiment E
91940 Les Ulis - FRANCE

Tel: +33 9 72 38 17 80
Fax: +33 9 72 11 21 69
Mail: sales@effilux.fr

Copyright 2021 Effilux - All rights Reserved

THE FLEXIBILITY OF THE EFFI-FLEX WITH AN EXTENDED SPECTRUM

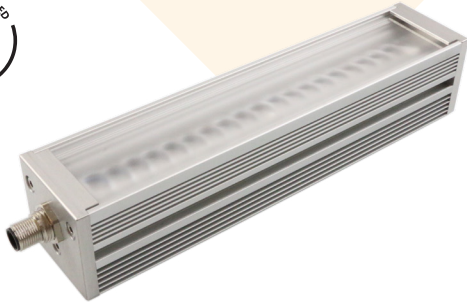

The **X2 VIS-NIR version** of the EFFI-Flex-HSI integrates two additional **NIR LEDs** (910nm and 970nm) offering an **extended spectrum** from 400 to 1000nm.

This version allows for independant control of each channel (Broadband White, 910nm and 970nm) in order to adapt the spectrum to your needs and to your camera sensitivity.

EFFI-FLEX-HSI - X2	- XXXX	- 910-970	- WW	- PP	- ELS-UUU
Doubled LED density	Optical Length (mm)	Additional IR LEDs	Window	Lens position	Range of the AIC:
	200 300 400 ... All 100mm 1000		TR (Transparent) SD (Semi-diffuse) OP (Opaline)	P0 (90°) P1 (45°) P2 (25°) P3 (10°)	ELS-24V ELS-10V ELS-5V

STANDARD VERSION AND EXTENDED SPECTRUM VERSION COMPARISON

	Spectrum	Number of LEDs	AIC Version	AutoStrobe feature	Illuminance at XXm of working distance
EFFI-Flex-HSI	400-900 nm	5 LEDs per 100mm	✓	✓	XX meters
EFFI-Flex-HSI-X2 VIS-NIR	Extended spectrum 400-1000 nm	10 LEDs per 100mm	✓	✗	XX meters

SPECTRUM

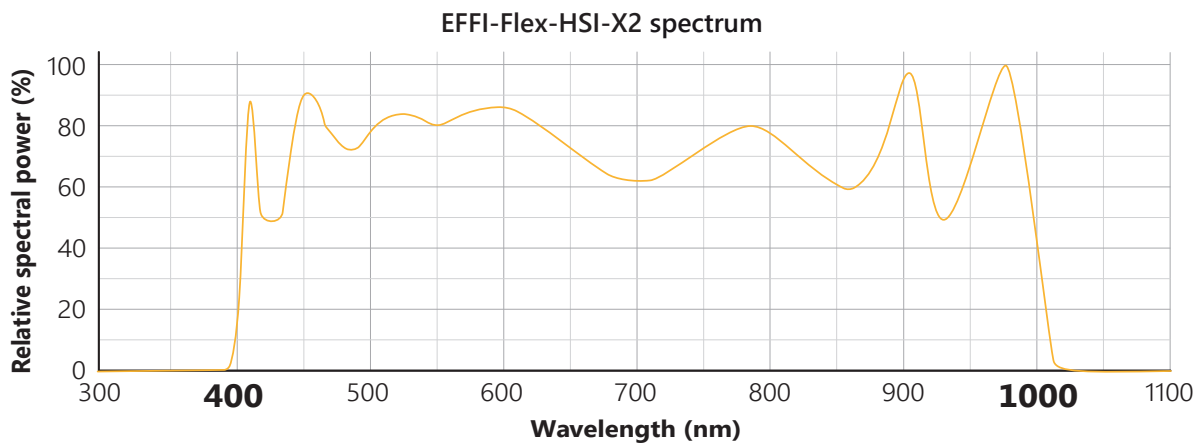

Note: This spectrum has been measured with adjusted NIR LEDs intensities in order to get a flat spectrum. If all channels are set to 100% intensity, the peaks at 910nm and 970nm are higher, helping to compensate for the camera's lack of sensitivity in the NIR range.

The EFFI-Flex-HSI requires time to stabilize his spectral emission. Please note that during this stabilization, the spectral power may decrease by maximum 10%.

At ambient temperature 25°C, this stability is reached 35 minutes after switching on the product.

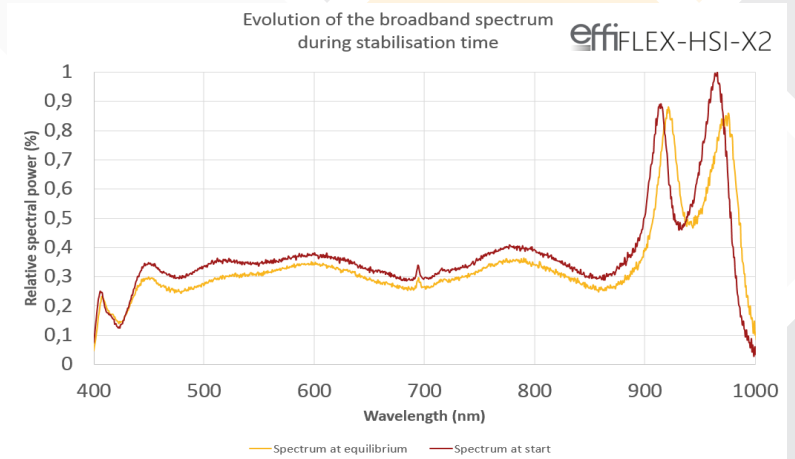

ELECTRONICAL SPECIFICATION - X2 VIS-NIR VERSION

Wiring Layout

The EFFI-Flex-HSI-X2 VIS-NIR requires 24V DC input power and is only compatible with the Analog Intensity Control version (AIC).

For specifications about the AIC version, please refer to the standard version (Cf. page 6).

M12 - 5 pins

male connector

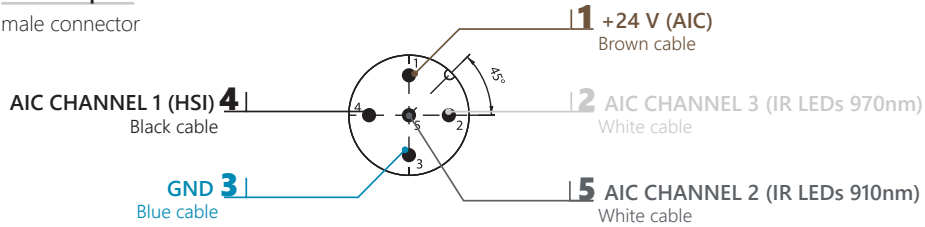

Power consumption and Connector type

The EFFI-Flex-HSI-X2 VIS-NIR has a standard M12 connector (5 pins). The exact power consumption of the product is always indicates on the product's stickers.

MAX POWER CONSUMPTION (X2 VERSION)									
Optical length (mm)	200	300	400	500	600	700	800	900	
Channel 1 (HSI)	15W	25W	30W	35W	45W	50W	55W	60W	For other optical length, please contact Effilux.
Channel 2 (IR 910)	5W	5W	5W	5W	5W	5W	5W	5W	
Channel 3 (IR 970)	5W	5W	5W	5W	5W	5W	5W	5W	

M12
5 pins

HYPERSPECTRAL LINEAR LIGHTING

EFFILUX line scan options provide high uniformity linear lighting. Those options can be used in conjunction with line scan camera for short and long range line scan inspection applications.

Both standard and X2 version of the EFFI-Flex-HSI benefit from the two linescan options.

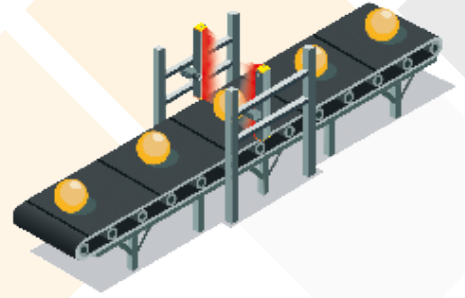

OPTION: LINESCAN ACCESSORY

With the lens in the upper position, the linescan accessory transforms the EFFI-Flex-HSI light into a uniform line light ideal for either brightfield or darkfield illumination.

The linescan accessory can be insert inside the EFFI-Flex-HSI by the user just under the window.

Additionally to the linescan accessory, the cylindrical lens is a specific optical system that will focus the light into a very bright line.

The cylindrical lens version of the EFFI-Flex-HSI is a specific product.



Optical impact



Without linescan or cylindrical lens



With linescan

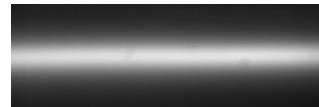

With cylindrical lens